

Beauty Beautiful Finish

Professional

The perfect system SLIMDUCT with various fittings will conceal, beautify and protect exposed linesets and is suitable for any Split Air Conditioners.

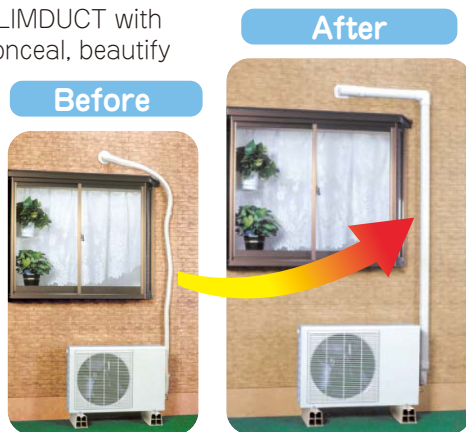

Protective

SLIMDUCT is constructed from a special high grade PVC for superior UV and weather resistance, protecting linesets from the elements, vandalism and pest damage.

SLIMDUCT SD

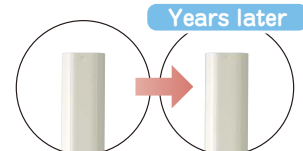

Taping Installation

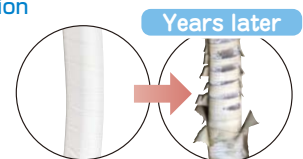

Variety Wide Range of Variation

Color

5 colors to provide a wide range to suit any color scheme.

Paintable to match or compliment custom colors. Follow paint manufacturer's recommendations for vinyl products.



Size

3 sizes to accommodate any single lineset or multiple linesets.

Fittings

A full range of different fittings to customize SLIMDUCT SD / NSD to suit the layout of lineset.

※For further information, visit our website.

Function Excellent Performance

Flame Retardant

SLIMDUCT SD/NSD is made from flame retardant materials.*

* Excludes some items.

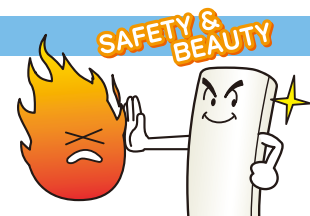

Vertical flame test (internal test)

Burned the end of the duct by a burner for 20 seconds.



Ignited by a burner

Self-extinguished

SLIMDUCT was self-extinguished immediately.

Other flammable duct kept burning, burned down with flame, and completely was destroyed in about 5 minutes.

Examples

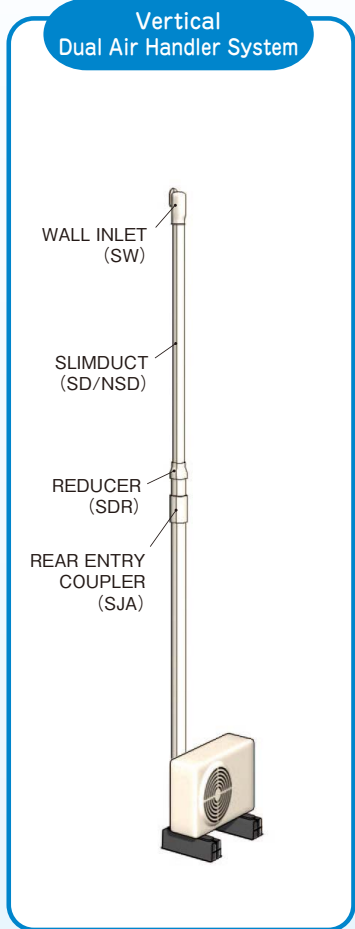
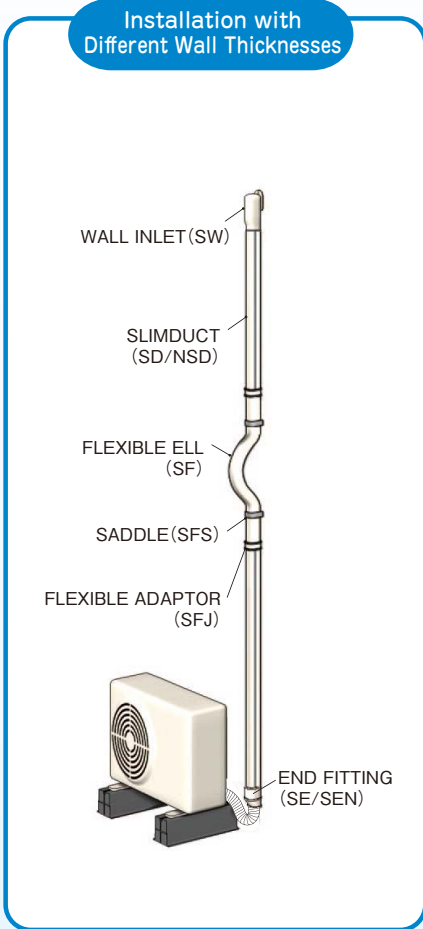
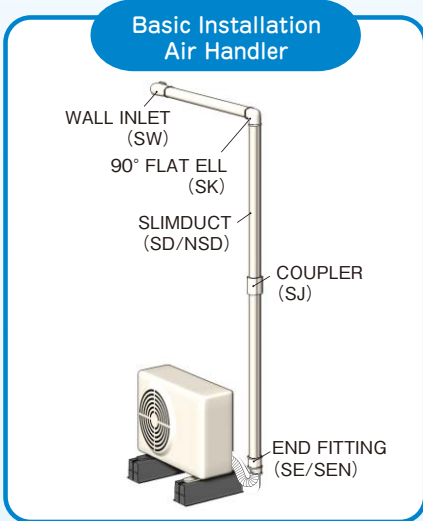
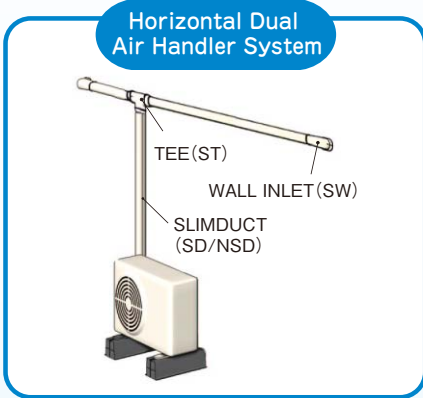

SD SLIMDUCT SD Ducting



Dimensions

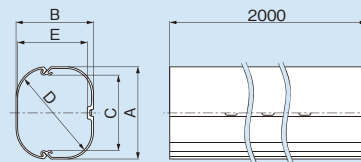

Unit : mm

Code No.	Item No.	A	B	C	D	E	Pcs/Pkg
☑ 0402	SD- 77	75	63	60	76	56	15
☑ 0403	SD-100	100	70	86	99	64	10
☑ 0404	SD-140	140	80	122	135	73	5

NSD NEO SLIMDUCT NSD < Overseas Model > Ducting

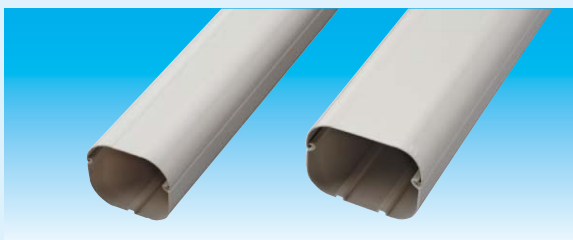

Dimensions

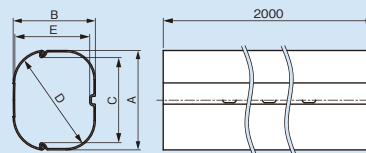

Unit : mm

Code No.	Item No.	A	B	C	D	E	Pcs/Pkg
☑ 1402	NSD- 77	75	62	64	77	56	10
☑ 1403	NSD-100	100	70	84	100	64	10

● Color ... White, Ivory, Brown

SW WALL INLET

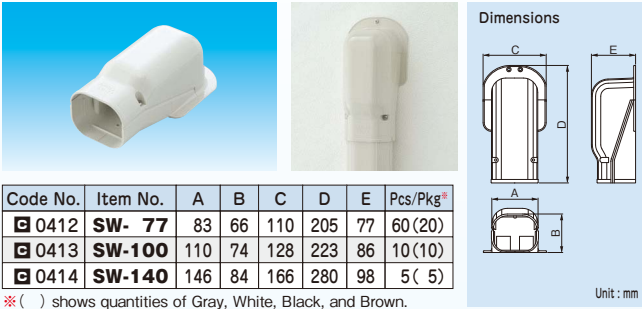

Dimensions

Code No.	Item No.	A	B	C	D	E	Pcs/Pkg*
☐ 0412	SW- 77	83	66	110	205	77	60 (20)
☐ 0413	SW-100	110	74	128	223	86	10 (10)
☐ 0414	SW-140	146	84	166	280	98	5 (5)

Unit : mm

* () shows quantities of Gray, White, Black, and Brown.

SWA WALL INLET for Aftermarket Add-ons

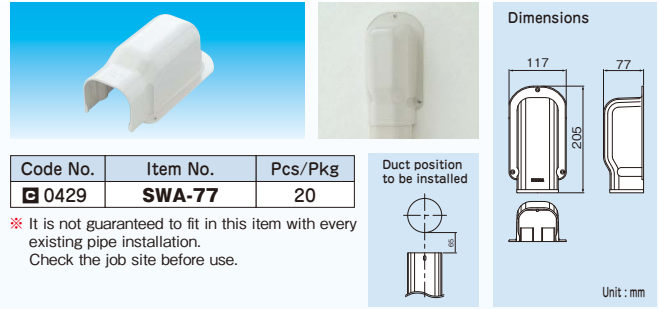

Dimensions

Code No.	Item No.	Pcs/Pkg
☐ 0429	SWA-77	20

Unit : mm

☐ It is not guaranteed to fit in this item with every existing pipe installation. Check the job site before use.

Duct position to be installed

SWM WALL INLET for A/C Cap

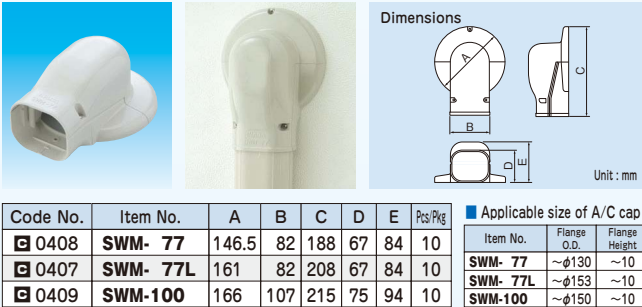

Dimensions

Code No.	Item No.	A	B	C	D	E	Pcs/Pkg
☐ 0408	SWM- 77	146.5	82	188	67	84	10
☐ 0407	SWM- 77L	161	82	208	67	84	10
☐ 0409	SWM-100	166	107	215	75	94	10

Unit : mm

■ Applicable size of A/C cap

Item No.	Flange O.D.	Flange Height
SWM- 77	~φ130	~10
SWM- 77L	~φ153	~10
SWM-100	~φ150	~10

SWK WALL INLET for A/C with Ventilation

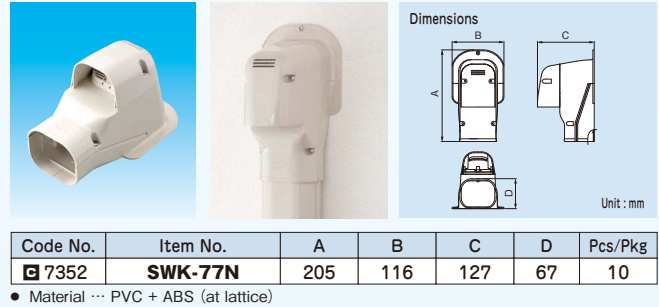

Dimensions

Code No.	Item No.	A	B	C	D	Pcs/Pkg
☐ 7352	SWK-77N	205	116	127	67	10

Unit : mm

● Material ... PVC + ABS (at lattice)

SWX WALL INLET for A/C Cap and A/C with Ventilation

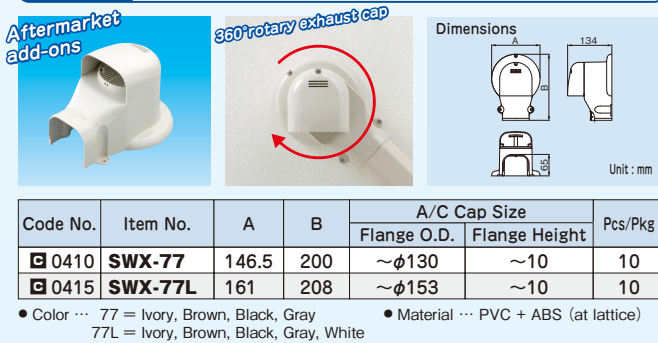

Aftermarket add-ons

360° rotary exhaust cap

Dimensions

Code No.	Item No.	A	B	A/C Cap Size		Pcs/Pkg
				Flange O.D.	Flange Height	
☐ 0410	SWX-77	146.5	200	~φ130	~10	10
☐ 0415	SWX-77L	161	208	~φ153	~10	10

Unit : mm

● Color ... 77 = Ivory, Brown, Black, Gray
77L = Ivory, Brown, Black, Gray, White

● Material ... PVC + ABS (at lattice)

SK 90° FLAT ELL

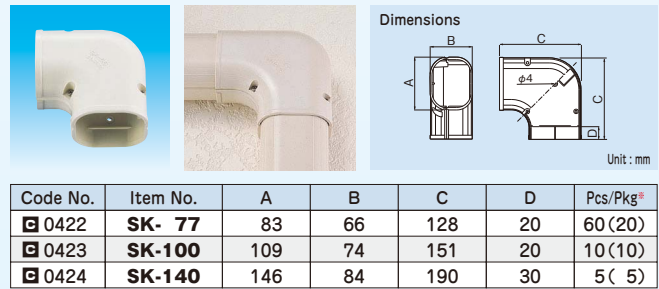

Dimensions

Code No.	Item No.	A	B	C	D	Pcs/Pkg*
☐ 0422	SK- 77	83	66	128	20	60 (20)
☐ 0423	SK-100	109	74	151	20	10 (10)
☐ 0424	SK-140	146	84	190	30	5 (5)

Unit : mm

* () shows quantities of Gray, White, Black, and Brown.

SKM 90° MINI FLAT ELL

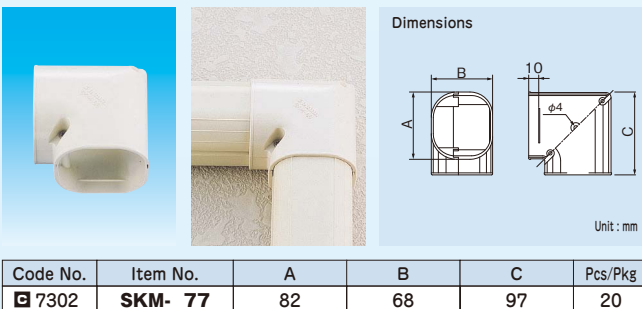

Dimensions

Code No.	Item No.	A	B	C	Pcs/Pkg
☐ 7302	SKM- 77	82	68	97	20

Unit : mm

SKF 45° FLAT ELL

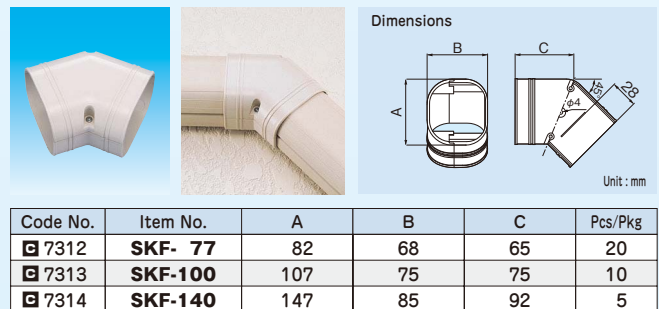

Dimensions

Code No.	Item No.	A	B	C	Pcs/Pkg
☐ 7312	SKF- 77	82	68	65	20
☐ 7313	SKF-100	107	75	75	10
☐ 7314	SKF-140	147	85	92	5

Unit : mm

SC 90° VERTICAL ELL

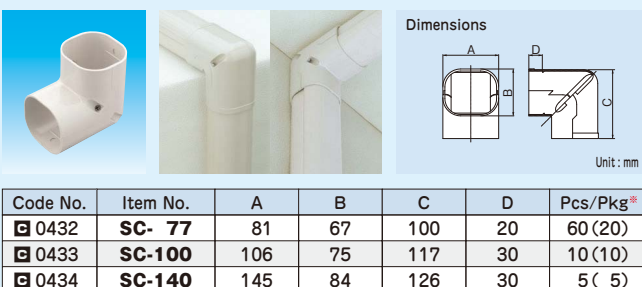

Dimensions

Code No.	Item No.	A	B	C	D	Pcs/Pkg*
☐ 0432	SC- 77	81	67	100	20	60 (20)
☐ 0433	SC-100	106	75	117	30	10 (10)
☐ 0434	SC-140	145	84	126	30	5 (5)

Unit : mm

* () shows quantities of Gray, White, Black, and Brown.

SCM 90° MINI VERTICAL ELL

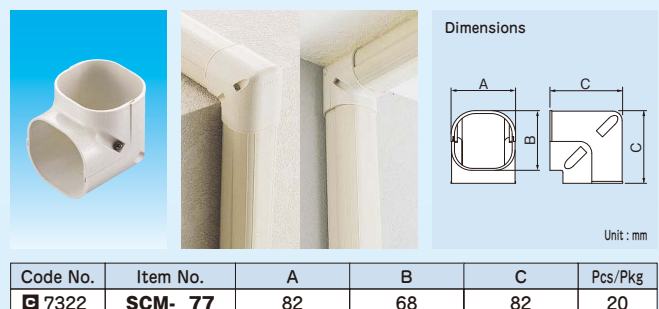

Dimensions

Code No.	Item No.	A	B	C	Pcs/Pkg
☐ 7322	SCM- 77	82	68	82	20

Unit : mm

SCF 45° VERTICAL ELL

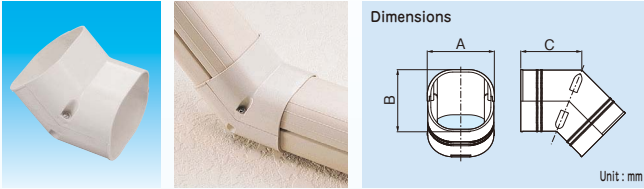

Code No.	Item No.	A	B	C	Pcs/Pkg
☐ 7332	SCF- 77	82	68	61	20
☐ 7333	SCF-100	107	75	64	10
☐ 7334	SCF-140	147	85	67	5

SN 90° SHAPE CHANGE ELBOW

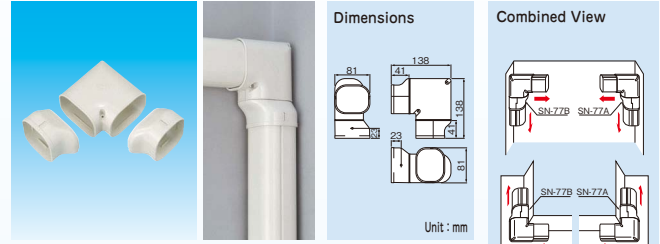

Code No.	Item No.	Pcs/Pkg
☐ 0517	SN-77	5

ST TEE

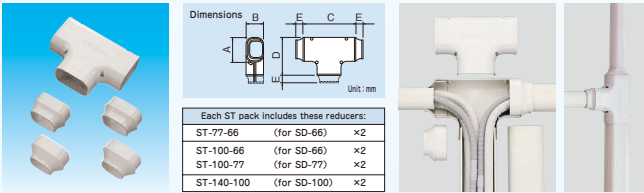

Code No.	Item No.	A	B	C	D	E	Pcs/Pkg
☐ 0462	ST- 77	85	68	165	124	31	10
☐ 0461	ST-100	109	78	200	154	33	10
☐ 0463	ST-140	148	87	250	199	32	5

SJ COUPLER



Code No.	Item No.	A	B	C	Pcs/Pkg*
☐ 0442	SJ- 77	85	67	50	60 (20)
☐ 0443	SJ-100	109	75	66	20 (20)
☐ 0444	SJ-140	146	84	90	10 (10)

* () shows quantities of Gray, White, Black, and Brown.

SDR REDUCER



Code No.	Item No.	A	B	C	D	E	Pcs/Pkg
☐ 0477	SDR100- 77	66	75	82	107	66	20
☐ 0478	SDR140-100	75	84	109	147	100	10

SIF 50MM FIXED OFFSET

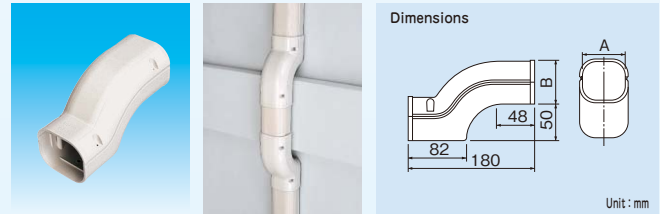

Code No.	Item No.	A	B	Pcs/Pkg
☐ 0417	SIF- 77	83	69	10
☐ 0418	SIF-100	108	74	10

SJA REAR ENTRY COUPLER

Dimensions

Unit : mm

■ Typical Installation

■ Caulking Locations

Code No.	Item No.	A	B	C	D	E	Compliant pipe size	Pcs/Pkg
☐ 0445	SJA-100	109	75	148	70	88	2 sets of PC-2320	20

SE END FITTING



Code No.	Item No.	A	B	C	D	E	Pcs/Pkg*
☐ 0449	SE-77	53	43	45	82	67	60 (20)

* () shows quantities of Gray, White, Black, and Brown.

SEN END FITTING

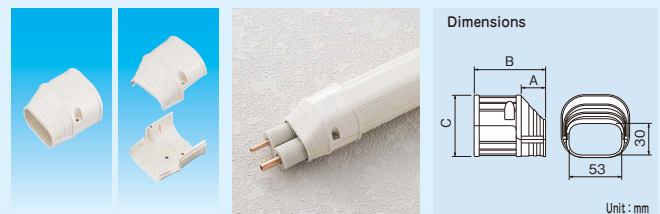

Code No.	Item No.	A	B	C	Pcs/Pkg
☐ 0488	SEN-100	56	112	76	20
☐ 0489	SEN-140	77	150	85	10

SWC WALL FLANGE



Code No.	Item No.	A	B	C	D	E	F	G	Diameter of core drill	Pcs/Pkg
☐ 0482	SWC- 77	83	71	127	115	80	110	90	85	100
☐ 0483	SWC-100	108	78	174	144	104	140	114	110	50
☐ 0484	SWC-140	148	88	220	180	144	196	154	145	20

● Material ... ABS

SP SOFFIT INLET



Code No.	Item No.	A	B	C	D	E	Pcs/Pkg
☐ 7342	SP- 77	81	67	110	130	100	20
☐ 7343	SP-100	106	74	135	137	107	10
☐ 7344	SP-140	146	84	175	147	117	5

● Material ... ABS

SF FLEXIBLE ELL with End Cuffs

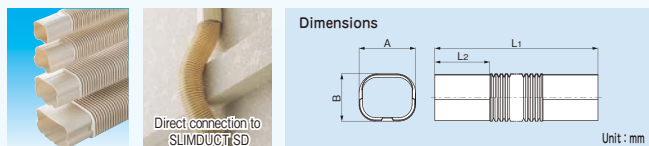

Code No.	Item No.	A	B	L1	L2	Pcs/Pkg
☐ 0453	SF- 77- 500	74	62	495	72	20
☐ 0454	SF- 77-1000	74	62	1033	72	20
☐ 0455	SF-100- 800	100	70	800	70	10
☐ 0456	SF-140- 800	146	86	800	80	5

● Material ... PE(77), PP(100/140)

SFS SADDLE for FLEXIBLE ELL SF

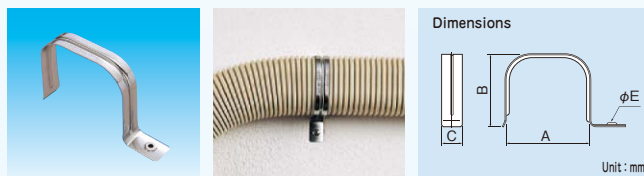

Code No.	Item No.	A	B	C	E	Pcs/Pkg
☐ 0612	SFS- 77	75	63	18	4.2	60
☐ 0613	SFS-100	100	70	22	7	40
☐ 0614	SFS-140	146	85	22	7	40

● Material ... SUS304

SF 2M FLEXIBLE ELL with Raw Ends

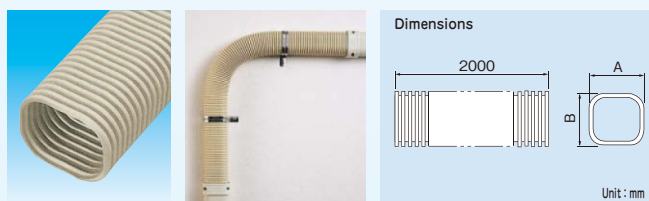

Code No.	Item No.	A	B	Pcs/Pkg
☐ 0460	SF-77-2000	74	62	10

● Material ... PE

※ Use only in conjunction with SFJ Coupler and SFS Clamp.

SFJ SF FLEXIBLE ADAPTOR



Code No.	Item No.	A	B	C	Pcs/Pkg
☐ 0437	SFJ- 77	83	66	35	20
☐ 0438	SFJ-100	108	74	40	20

※ Use in combination with SFS.

※ For secure joint, insert 2 corrugations of SF into SFJ adaptor.

Application Example for FLEXIBLE ELL

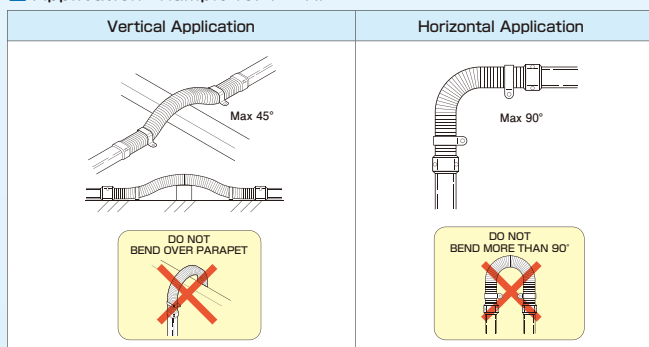

SL STRAP KIT

For SLIMDUCT

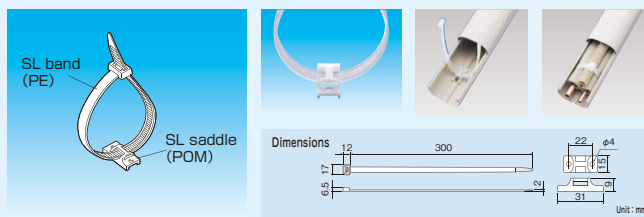

Code No.	Item No.	Pcs/Pkg
☐ 04720	SL-300	500

● Material ... PE(SL band), POM(SL saddle)

※ Do not overtighten strap! This may decrease insulation performance.

Specifications

Temperature Range	-20°C~60°C
Application	Wall Mounted
Material	Rigid Polyvinyl Chloride (Flame Retardant) ※ Excludes some items
Color	Ivory Gray Brown White Black

※ Excludes some items.

• Most components are PVC. When other materials are used, they will be listed under the component description.

■ The table below shows the maximum size lineset combinations that can be contained in SLIMDUCT SD:

Insulation Thickness	10×10mm	10×20mm	20×20mm
SD- 77	φ9.52×φ15.88	—	—
SD-100	(φ19.05×φ22.22) or (φ6.35×φ9.52) ×2 sets	φ9.52×φ19.05	—
SD-140	(φ6.35×φ12.70 and φ9.52×φ15.88) ×2 sets	φ19.05×φ31.75	φ19.05×φ31.75

※ 10mm type of insulation thickness for φ6.35mm and φ9.52mm is 8mm. Piping system includes DRAIN HOSE (DH-16).

Caution

- SLIMDUCT SD IS NOT WATERPROOF. To waterproof, seal all longitudinal and lateral seams, screw heads and wall penetration with weatherproof sealant or putty.
- SLIMDUCT SD duct and fittings are suitable for use and storage within a temperature range of -20°C to 60°C. Deformation may occur at temperatures exceeding 60°C. Protect SLIMDUCT installation from direct and radiant heat.
- When attaching SLIMDUCT to wall, USE ONLY PAN HEAD SCREWS. DO NOT USE FLAT HEAD OR COUNTERSUNK SCREWS AS THEY CAN EXERT TOO MUCH PRESSURE AND CRACK THE PVC MATERIAL.
- Use of impact screwdrivers to attach SLIMDUCT to wall and to tighten fixing screws on fittings is highly discouraged as they can easily overtighten the screws and crack the PVC material. Use hand screwdrivers for precise torque control.
- Use SL-300 STRAP KIT to retain lineset inside duct.